

Tools and equipment you will need:

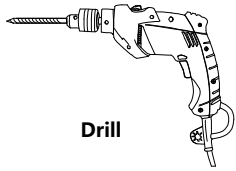

Drill

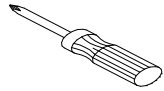

Phillips-head screwdriver



Pencil

Robe hook

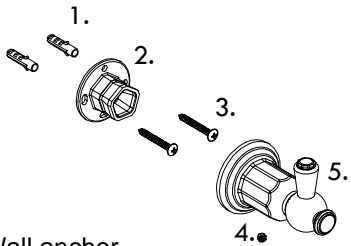

1. Wall anchor
2. Mounting plate
3. Screws
4. Set screw
5. Robe hook

Toilet paper holder

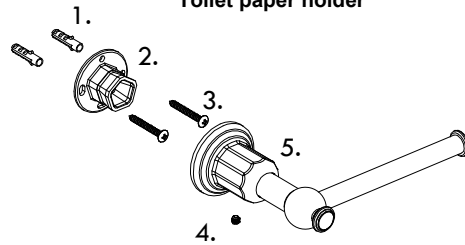

1. Wall anchor
2. Mounting plate
3. Screws
4. Set screw
5. Toilet paper holder

Towel ring

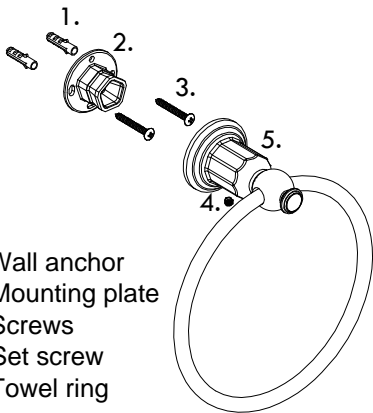

1. Wall anchor
2. Mounting plate
3. Screws
4. Set screw
5. Towel ring

1

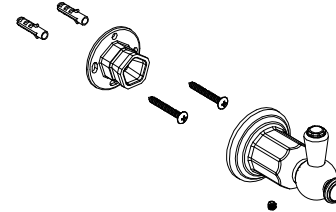

Mark the desired location for the accessory on the wall.

2

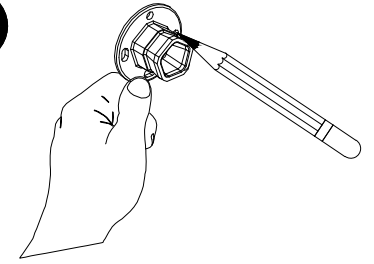

2a

Ø6mm (Ø15/64")

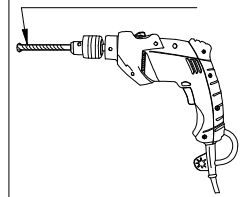

2b

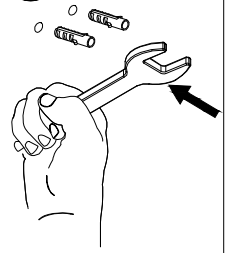

3

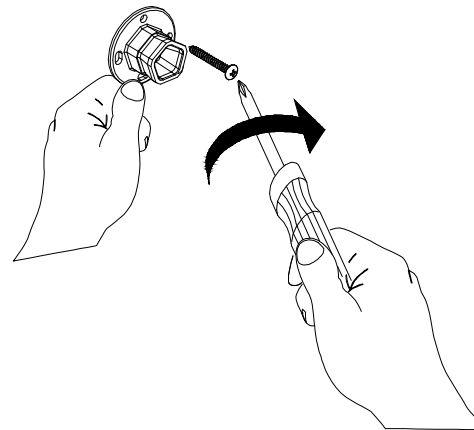

4

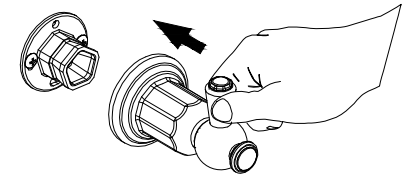

4a

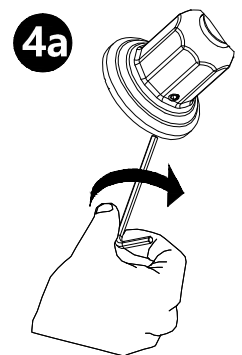

Tools and equipment you will need:

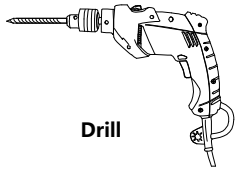

Drill

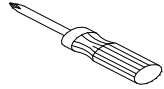

Phillips-head screwdriver



Pencil

18"/24" Towel bar

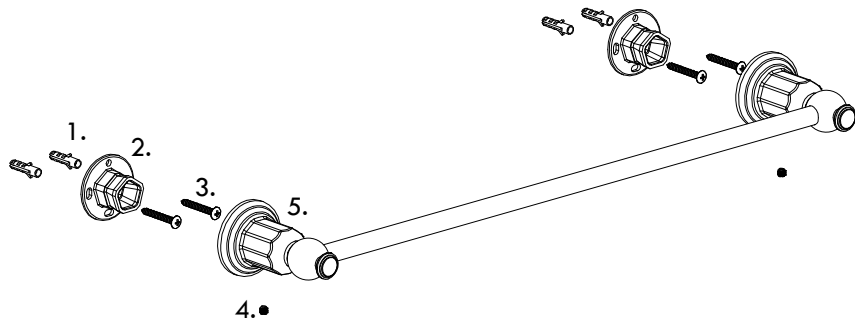

- 1. Wall anchor
- 2. Mounting plate
- 3. Screws
- 4. Set screw
- 5. Towel bar

1

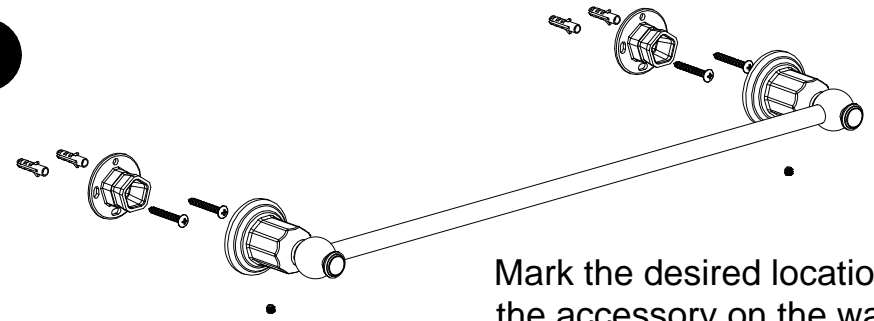

Mark the desired location for the accessory on the wall.

2

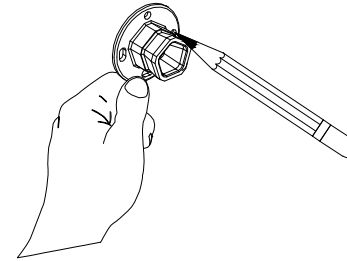

2a

Ø6mm (Ø15/64")

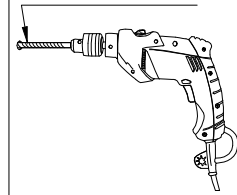

2a

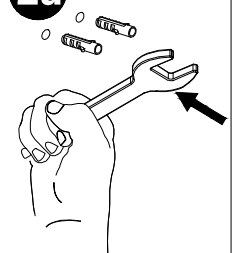

3

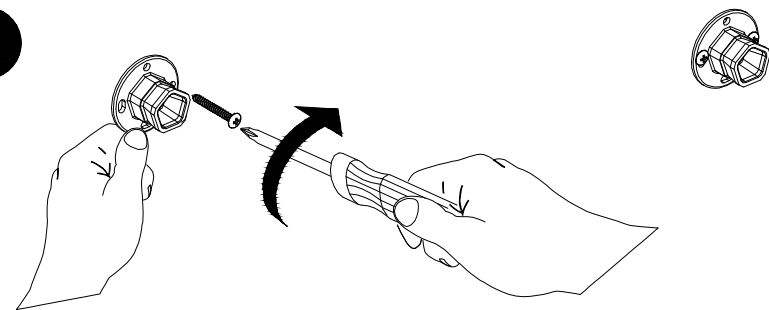

4

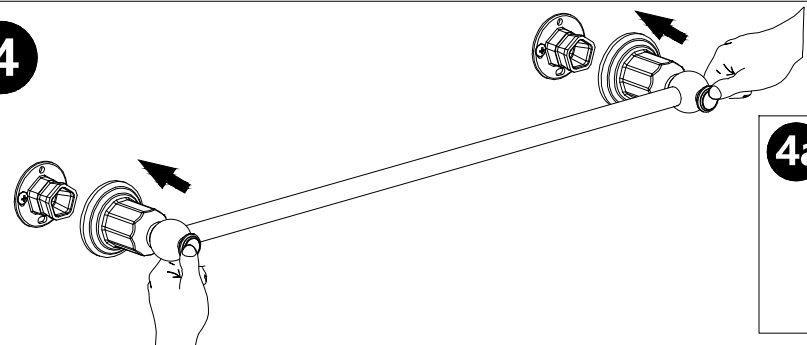

4a

