

# KAPFENBERG

## 2-WAY PRESSURE BALANCED SHOWER TRIM

TM.AP.210.210

### Components Included

---

- **TM.KG.210** - Trim for 2-way pressure balanced valve
- **SH.41.0808** - 8" square shower head
- **WA.41.16** - 16" wall mount shower arm with ½" female NPT connection
- **BH.01.01** - 31 ½" sliding shower bar with hose and 4 function hand shower (HS.01.01)
- **EC.41.01** - Square elbow connector with ½" female NPT connection

### Available Finishes

---

- Chrome (CC)
- Matte Black (MB)

(Model Pictured: Chrome)

### Codes / Standards

---

- Uniform Plumbing Code (UPC®)
- ASME A112.18.1/CSA B125.1
- ASSE 1016

### Warranty

---

- Valve & cartridge - Limited lifetime warranty
- Components - Limited lifetime warranty  
(see full warranty for details)



# KAPFENBERG

## 2-WAY PRESSURE BALANCED TRIM

TM.KG.210

### Description

- **TM.KG.210** - Trim for 2-way pressure balanced valve
- 3 positions

### Flow Rate

- 5.5 gpm | 21 lpm | 60 psi

### Cartridge

- CE.1440.PB - cartridge
- CE.1403.DR - diverter

### Available Finishes

- Chrome (CC)
- Brushed Nickel (BN)
- Matte Black (MB)
- Brushed Gold (BG)

(Model Pictured: Chrome)

### Codes / Standards

- Uniform Plumbing Code (UPC®)
- ASME A112.18.1/CSA B125.1
- ASSE 1016

### Warranty

- Limited lifetime warranty  
(see full warranty for details)

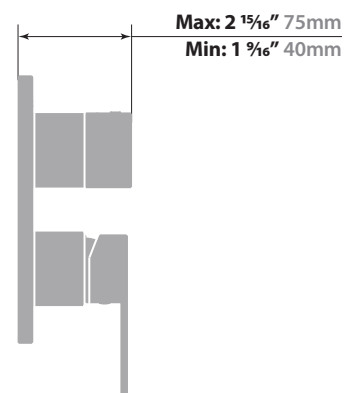
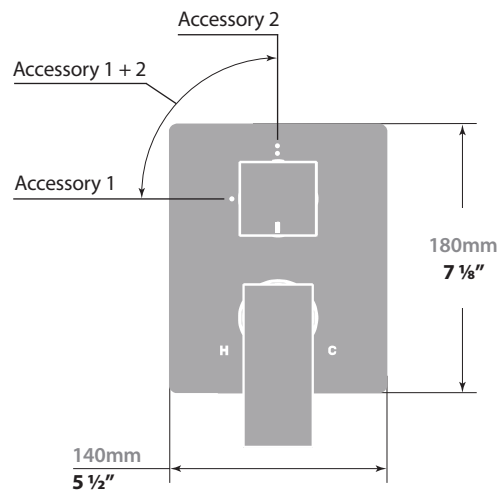
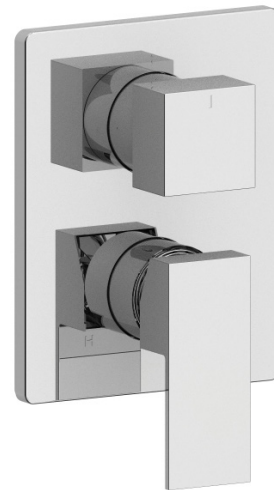

### 16" WALL ARM

WA.41.16

#### Description

- 16" wall mount shower arm with 1/2" female NPT connection
- Round pipe with square escutcheon plate

#### Available Finishes

- Chrome (CC)
- Matte Black (MB)
- Brushed Gold (BG)

(Model Pictured: Chrome)

#### Codes / Standards

- Uniform Plumbing Code (UPC®)
- ASME A112.18.1/CSA B125.1

#### Warranty

- Limited lifetime warranty (see full warranty for details)

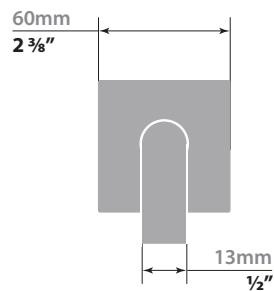
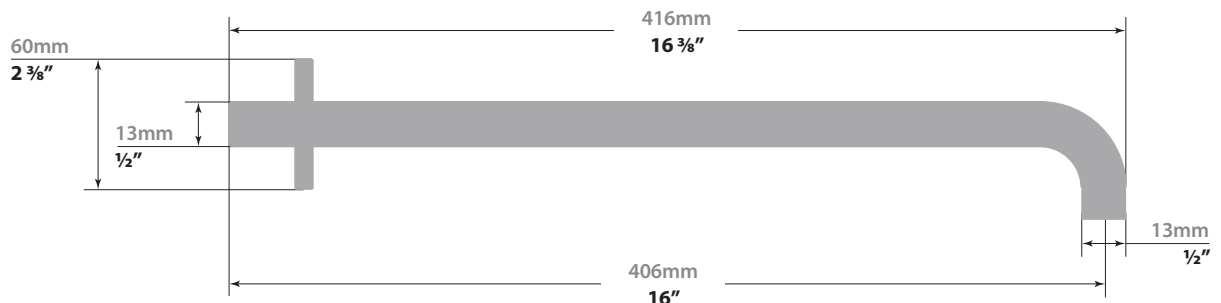

### 8" SQUARE SHOWER HEAD

SH.41.0808

#### Description

- 8" square shower head
- Anti-limescale technology

#### Flow Rate

- 2 gpm | 7.6 lpm | 60 psi

#### Available Finishes

- Chrome (CC)
- Matte Black (MB)

(Model Pictured: Chrome)

#### Codes / Standards

- Uniform Plumbing Code (UPC®)
- ASME A112.18.1/CSA B125.1

#### Warranty

- Limited lifetime warranty  
(see full warranty for details)

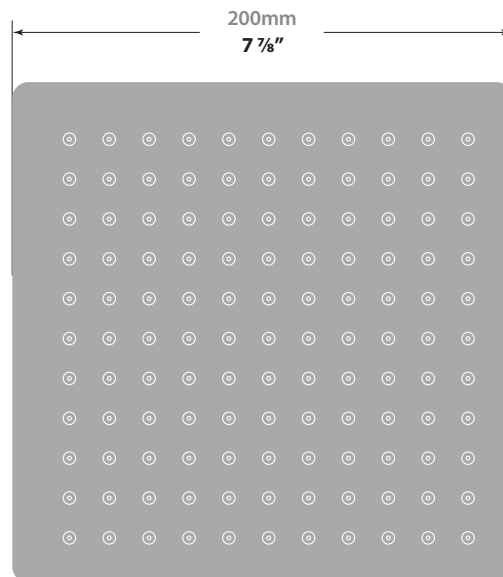
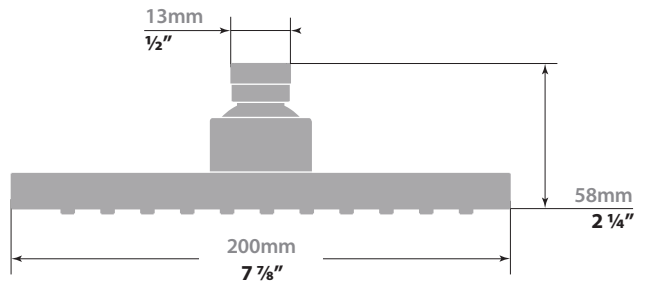
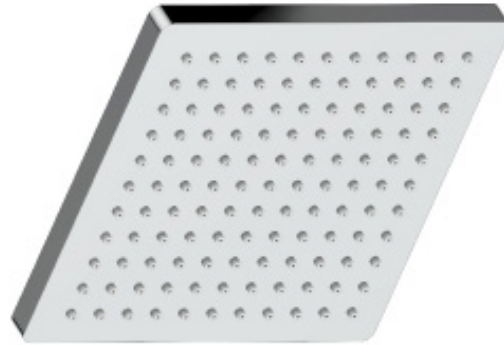

# KAPFENBERG

## SLIDING SHOWER BAR WITH HANDSHOWER

BH.01.01

### Description

- SB.01.31 - 31 ½" sliding shower bar
- HE.150 - 59" hose
- HS.01.01 - 1-function hand shower

### Flow Rate

- 2 gpm | 7.6 lpm | 60 psi

### Available Finishes

- Chrome (CC)
- Brushed Nickel (BN)
- Matte Black (MB)

(Model Pictured: Chrome)

### Codes / Standards

- Uniform Plumbing Code (UPC®)
- ASME A112.18.1/CSA B125.1
- ASSE 1016

### Warranty

- Limited lifetime warranty  
(see full warranty for details)



### SQUARE WALL SUPPLY ELBOW

EC.41.01

#### Description

- Square elbow connector with 1/2" female NPT connection

#### Available Finishes

- Chrome (CC)
- Brushed Nickel (BN)
- Matte Black (MB)
- Brushed Gold (BG)

(Model Pictured: Chrome)

#### Codes / Standards

- Uniform Plumbing Code (UPC®)
- ASME A112.18.1/CSA B125.1

#### Warranty

- Limited lifetime warranty (see full warranty for details)

