

# CARINTHIA

## 3/4" HIGH FLOW THERMOSTATIC VALVE

VT.CX.150

### Description

- VE.150 - 3/4" High flow thermostatic valve
- TM.CX.150 - Trim for 3/4" high flow valve

### Flow Rate

- 12 gpm | 45 lpm | 60 psi

### Cartridge

- CE.2300.TT - Thermostatic cartridge

control handle

### Available Finishes

- Chrome (CC)
- Brushed Nickel (BN)
- Polished Nickel (PN)
- Brushed Gold (BG)
- Chrome/Matte Black (CB)
- Brushed Nickel/Matte Black (BB)
- Polished Nickel/Matte Black (PB)
- Brushed Gold/Matte Black (BGB)

(Model Pictured: Chrome)

### Codes / Standards

- Uniform Plumbing Code (UPC®)
- ASME A112.18.1/CSA B125.1

### Warranty

- Limited lifetime warranty  
(see full warranty for details)

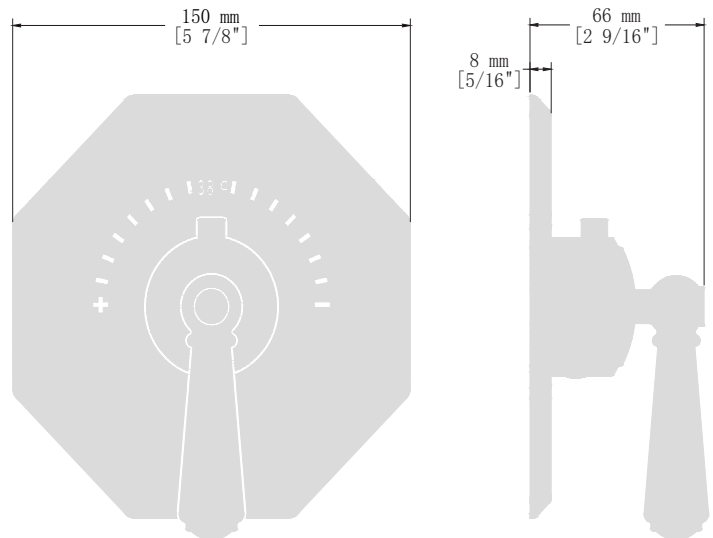
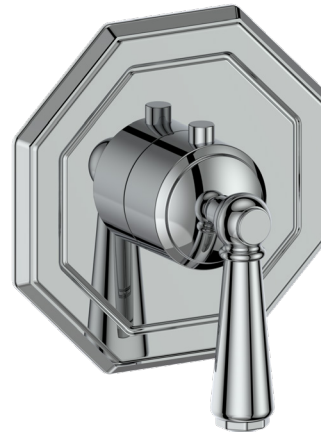

### 3/4" HIGH-FLOW THERMOSTATIC VALVE WITH 3 VOLUME CONTROL

VE.350

#### Description

- 3/4" high flow valve with thermostatic cartridge and 3 separate volume control
- 3/4" female NPT inlet connections

#### Flow Rate

- 12 gpm | 45 lpm | 60 psi

#### Cartridge

- CE.2300.TT - thermostatic cartridge
- CE.1700.R - volume control cartridge

#### Warranty

- Limited lifetime warranty  
(see full warranty for details)

#### Codes / Standards

- Uniform Plumbing Code (UPC®)
- ASME A112.18.1/CSA B125.1

