

ZEHN

WALL MOUNT TUB FILLER

BF.Z4.2200

Description

- Wall mount tub filler with 1 function hand shower
- Solid brass construction
- ½" male NPT connection

Cartridge

- CE.1700.R - ceramic disk cartridge (cold)
- CE.1700.L - ceramic disk cartridge (hot)
- CE.2001.DR - diverter cartridge

Flow Rate

- Handheld: 1.7 gpm | 6.6 lpm | 60 psi
- Tub Spout: 11 gpm | 41 lpm | 60 psi

Available Finishes

- Chrome (CC)
- Matte Black (MB)
- Polished Nickel (PN)
- Brushed Gold (BG)
- Matte Black / Chrome (CB)
- Matte Black / Stainless Steel (SB)
- Matte Black / Polished Nickel (PB)
- Brushed Gold / Matte Black (BGB)

(Model Pictured: Chrome)

Codes / Standards

- Uniform Plumbing Code (UPC®)
- ASME A112.18.1/CSA B125.1
- ASSE 1016

Warranty

- Limited lifetime warranty against all manufacturing defects to the original consumer purchaser (see full warranty for more details)

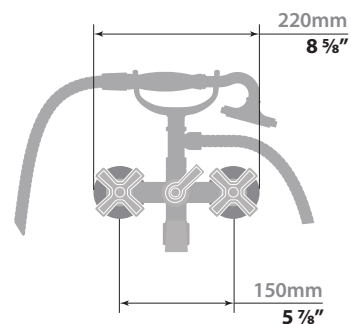
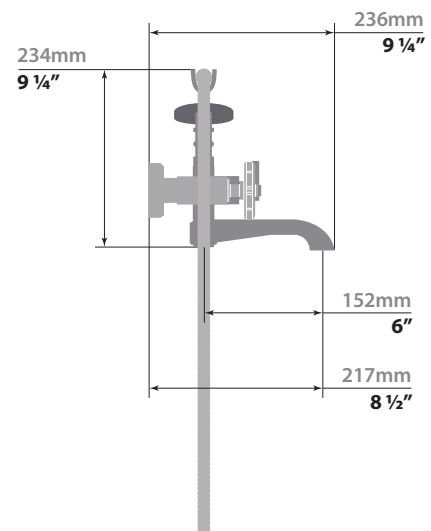

ROUGH-IN FOR WALL MOUNT TUB FILLER WITH ONE HANDLE

VE.2200

Description

- Solid brass construction
- ½" female NPT connection
- Full brass 15" x 5½" face plate

Flow Rate

- Handheld: 1.9 gpm / 7.2 lpm / 60 psi
- Tub spout: 5.8 gpm / 22 lpm / 60 psi

Cartridge

- CE.1440.PB - Ceramic disk cartridge
- CE.1922.DR - Ceramic diverter cartridge

Codes / Standards

- Uniform Plumbing Code (UPC®)
- ASME A112.18.1/CSA B125.1

Warranty

- Limited lifetime warranty against all manufacturing defects to the original consumer purchaser (see full warranty for more details)

