

ZEHN 2-WAY THERMOSTATIC SHOWER SYSTEM

SET.Z3.220.210

Components Included

- **VE.220** - Thermostatic valve with integrated 2-way diverter
- **TM.Z3.220** - Trim for 2-way thermostatic valve
- **SH.09.0808** - 8" round full brass shower head
- **WA.09.16** - 16" wall mount shower arm with ½" male NPT connection
- **BH.09.05** - 27" sliding shower bar with hose and 4-function hand shower (HS.09.05)
- **EC.09.01** - Round brass elbow connector with ½" female NPT connection

Available Finishes

- Chrome (CC)
- Matte Black (MB)
- Polished Nickel (PN)
- Brushed Gold (BG)
- Chrome / Matte Black (CB)
- Stainless Steel / Matte Black (SB)
- Polished Nickel / Matte Black (PB)
- Brushed Gold / Matte Black (BGB)

(Model Pictured: Chrome)

Codes / Standards

- Uniform Plumbing Code (UPC®)
- ASME A112.18.1/CSA B125.1
- ASSE 1016

Warranty

- Limited Lifetime Warranty against all manufacturing defects to the original consumer purchaser (see full warranty for more details)

Please note that this shower kit is also available with a 4" ceiling arm (**CA.02.04**) & 8" ceiling arm (**CA.02.08**)

4" ceiling arm Configuration - **SET.Z3.220.214**

8" ceiling arm Configuration - **SET.Z3.220.218**



ZEHN

2-WAY THERMOSTATIC VALVE & TRIM WITH 3-SPOKE HANDLES

VT.Z3.220

Description

- **VE.220** - 1/2" thermostatic valve with 2-way diverter
- **TM.Z3.220** - Trim for 2-way thermostatic valve
- 3 positions

Flow Rate

- 6.1 gpm / 23 lpm / 60 psi

Cartridge

- CE.1401.TT - cartridge
- CE.1710.DR - diverter

Available Finishes

- Chrome (CC)
- Matte Black / Chrome (CB)
- Matte Black (MB)
- Matte Black / Stainless Steel (SB)
- Polished Nickel (PN)
- Matte Black / Polished Nickel (PB)
- Brushed Gold (BG)
- Matte Black / Brushed Gold (BGB)

(Model Pictured: Chrome)

Codes / Standards

- Uniform Plumbing Code (UPC®)
- ASME A112.18.1/CSA B125.1
- ASSE 1016

Warranty

- Limited lifetime warranty
(see full warranty for details)

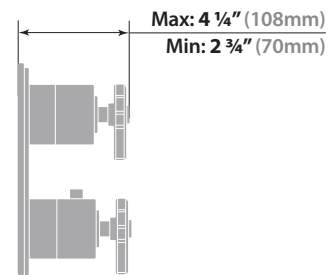
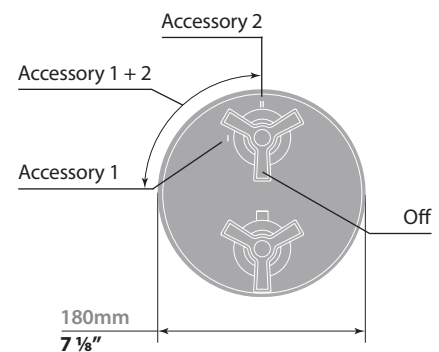

VE.220 - 2-Way Thermostatic Valve

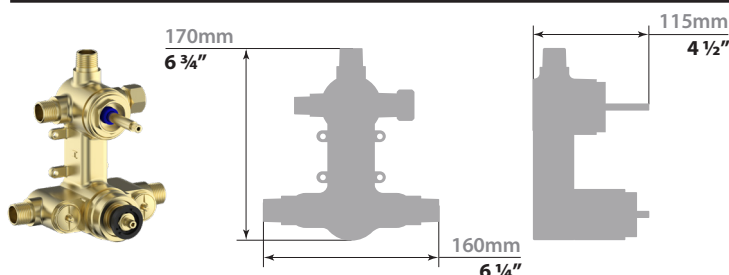

2-WAY THERMOSTATIC VALVE

VE.220

Description

- Valve with thermostatic cartridge and 2-way diverter
- ½" male NPT connections

Flow Rate

- 6.1 gpm | 23 lpm | 60 psi

Cartridge

- CE.1401.TT cartridge
- CE.1710.DR diverter

Codes / Standards

- Uniform Plumbing Code (UPC®)
- ASME A112.18.1/CSA B125.1
- ASSE 1016

Warranty

- Limited lifetime warranty
(see full warranty for more details)

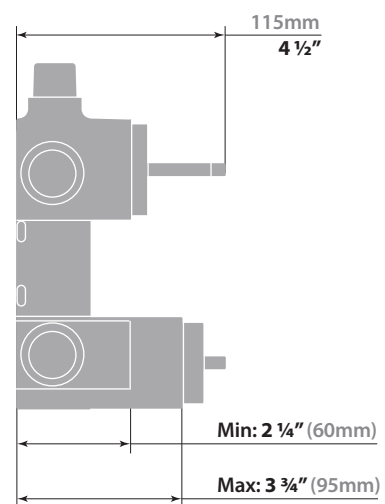
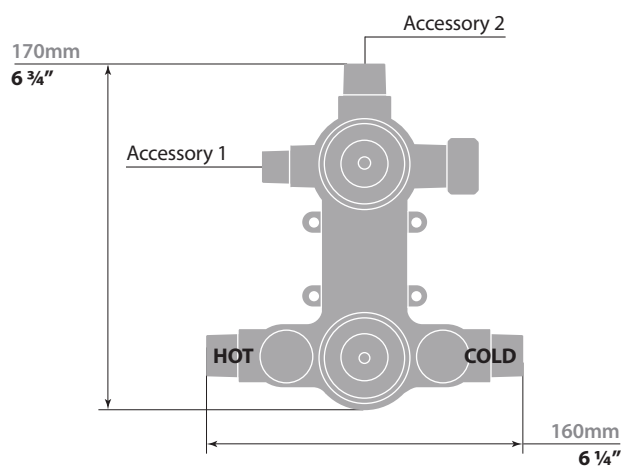
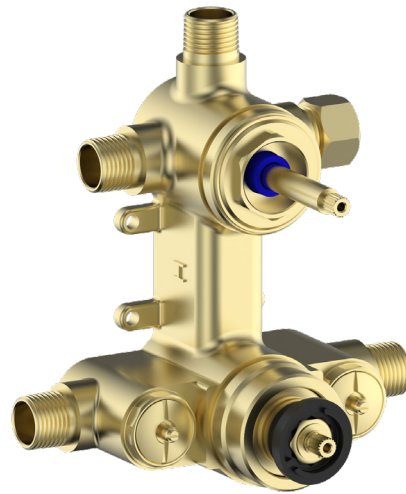

16" WALL ARM

WA.09.16

Description

- 16" wall mount shower arm with 1/2" male NPT connection
- Round pipe with round escutcheon plate

Available Finishes

- Chrome (CC)
- Matte Black (MB)
- Polished Nickel (PN)
- Brushed Gold (BG)
- Chrome / Matte Black (CB)
- Stainless Steel / Matte Black (SB)
- Polished Nickel / Matte Black (PB)
- Brushed Gold / Matte Black (BGB)

(Model Pictured: Chrome)



Codes / Standards

- Uniform Plumbing Code (UPC®)
- ASME A112.18.1/CSA B125.1

Warranty

- Limited lifetime warranty (see full warranty for details)

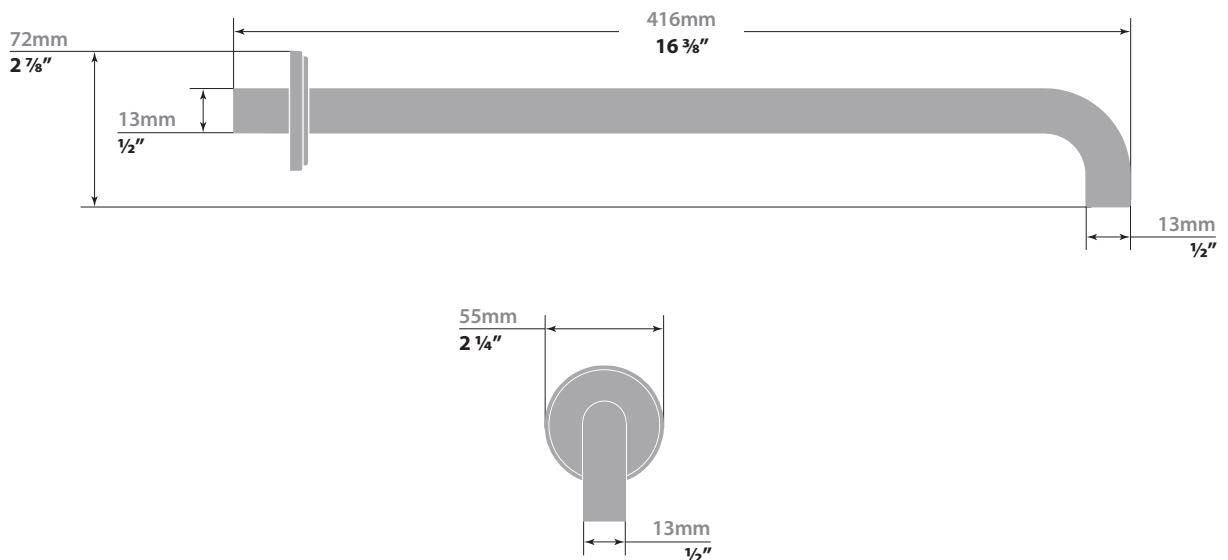

8" ROUND SHOWER HEAD

SH.09.0808

Description

- 8" round full brass shower head
- Anti-limescale technology

Flow Rate

- 2 gpm / 7.6 lpm / 60 psi

Available Finishes

- Chrome (CC)
- Matte Black (MB)
- Polished Nickel (PN)
- Brushed Gold (BG)

(Model Pictured: Chrome)

Codes / Standards

- Uniform Plumbing Code (UPC®)
- ASME A112.18.1/CSA B125.1

Warranty

- Limited lifetime warranty
(see full warranty for details)

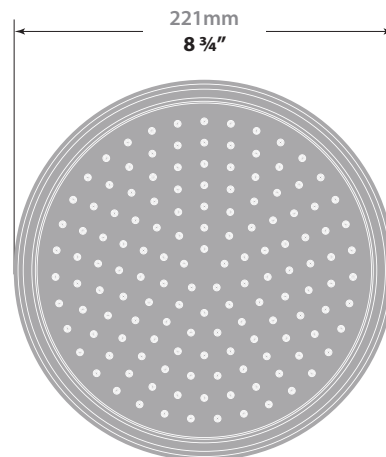
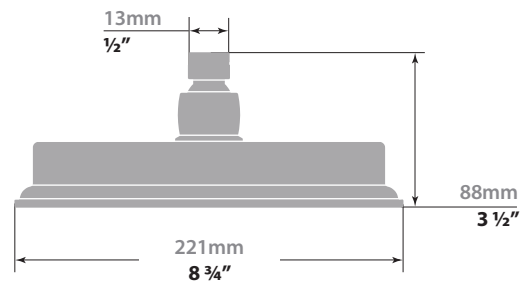

ZEHN

SLIDING SHOWER BAR WITH HANDSHOWER

BH.09.05

Description

- SB.09.27 - 27" sliding shower bar
- HE.150 - 59" hose
- HS.09.05 - 4-function hand shower

Flow Rate

- 2.0 gpm / 7.6 lpm / 60 psi

Available Finishes

- Chrome (CC)
- Matte Black (MB)
- Polished Nickel (PN)
- Brushed Gold (BG)
- Chrome / Matte Black (CB)
- Stainless Steel / Matte Black (SB)
- Polished Nickel / Matte Black (PB)
- Brushed Gold / Matte Black (BGB)

(Model Pictured: Chrome)

Codes / Standards

- Uniform Plumbing Code (UPC®)
- ASME A112.18.1/CSA B125.1
- ASSE 1016

Warranty

- Limited lifetime warranty
(see full warranty for details)

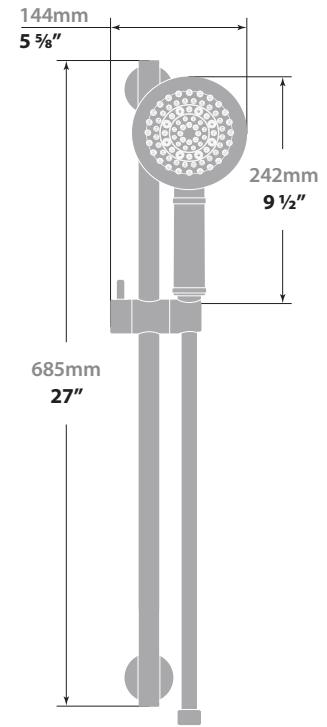

ROUND WALL SUPPLY ELBOW

EC.09.01

Description

- Round brass elbow connector with 1/2" female NPT connection

Available Finishes

- Chrome (CC)
- Matte Black (MB)
- Polished Nickel (PN)
- Brushed Gold (BG)
- Chrome / Matte Black (CB)
- Stainless Steel / Matte Black (SB)
- Polished Nickel / Matte Black (PB)
- Brushed Gold / Matte Black (BGB)

(Model Pictured: Chrome)

Codes / Standards

- Uniform Plumbing Code (UPC®)
- ASME A112.18.1/CSA B125.1

Warranty

- Limited lifetime warranty (see full warranty for details)

