

Model Name: NIVEAU 3-WAY TH
SHOWER SYSTEM
Model No: SET.NU.320.310.XX



VOGTINDUSTRIES.COM

Before you begin:

- Please take note of different standards and regulations that are dictated by your local plumbing codes. This product is certified in accordance with North American building codes.
- We insist that you use services of a professional plumber with experience in the installation of similar fixtures.
- Ensure that the piping system is well secured to prevent rattling, vibration and banging noises caused by a water hammer. We also recommend that you use water hammer arrestors.
- Ensure that the interior of the water pipes is clean from debris, sand, solder and any other residue.
- Always remove cartridges and other valve components before welding. Purge the water supply system for around 30 seconds, and then carefully reinstall the cartridges.

Tools and equipment you will need:

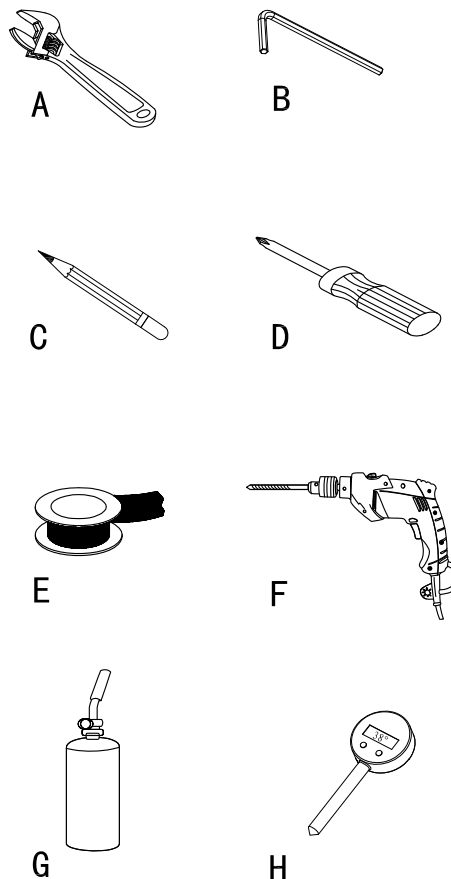

Waterway diagram:

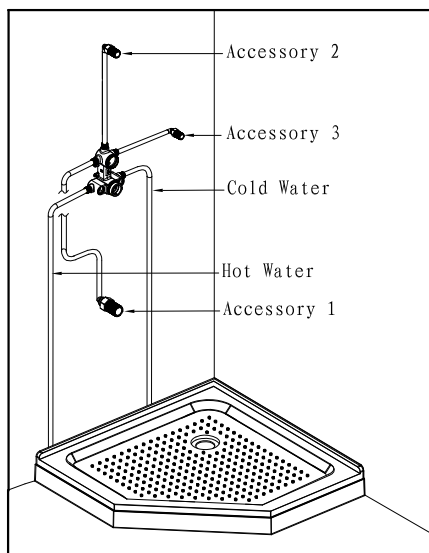

Accessories 1 & 2 can work at the same time.

Accessories 2 & 3 can work at the same time.

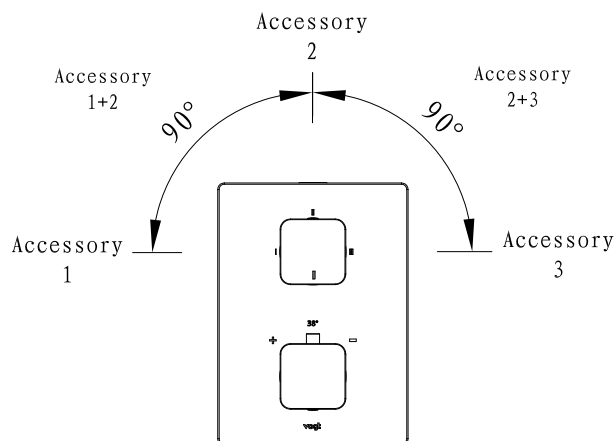

voigt

PURE QUALITY AND DESIGN

Parts/Assembly

Model Name: NIVEAU 3-WAY
TH SHOWER SYSTEM

Model No: SET.NU.320.310.XX

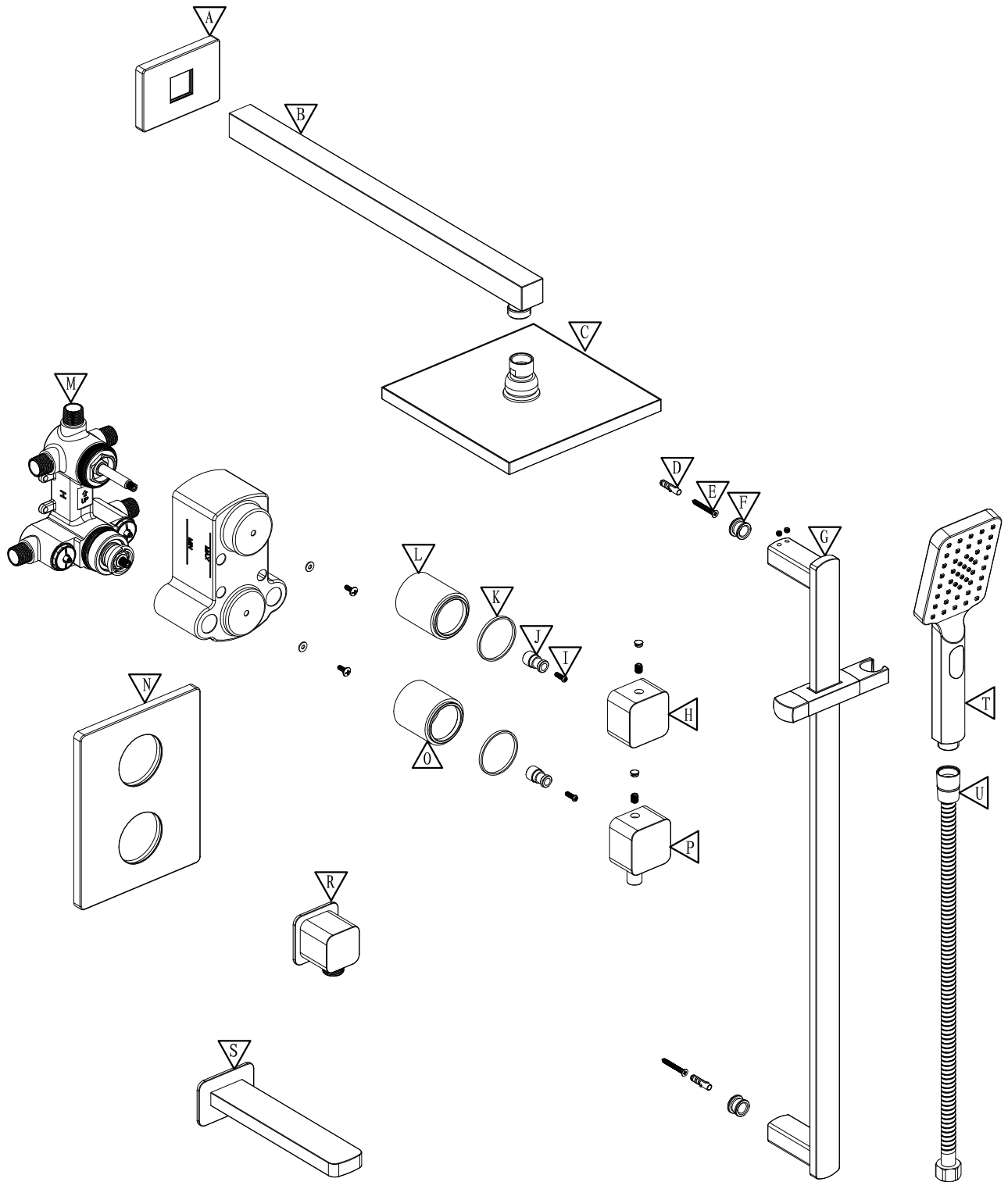

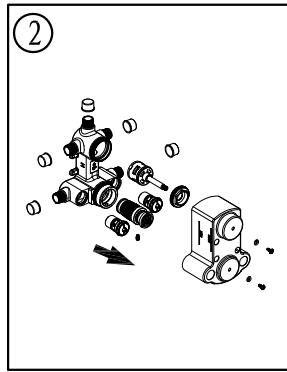
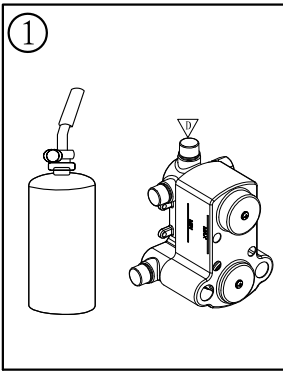

If welding is involved you must remove internal valve components prior to the welding. Please note the original position of the cartridge.

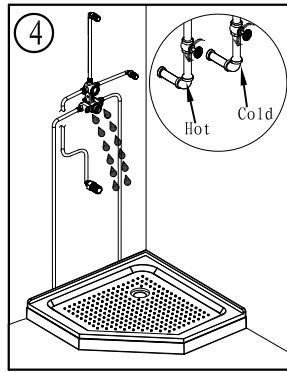
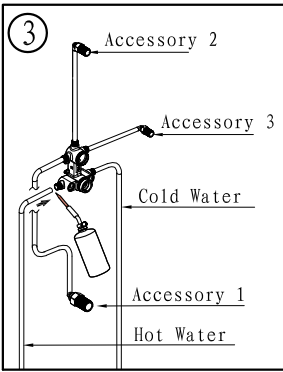

Once the welding is finished, purge the water supply system for around 30 seconds.

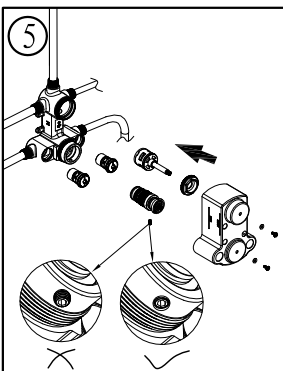

Reinstall the valve components into their original positions.

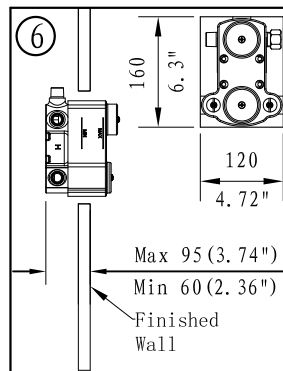

Make sure that the valve is installed in such a way that the finished wall is between the Max and Min marks.

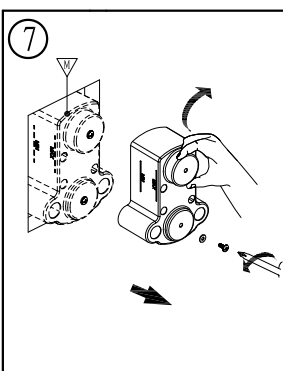

Remove the screws and take the plastic cover off the valve.

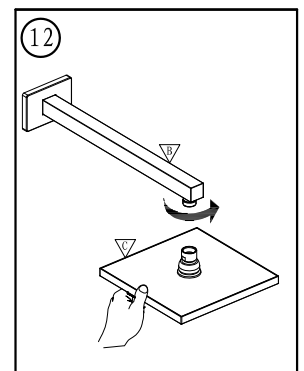
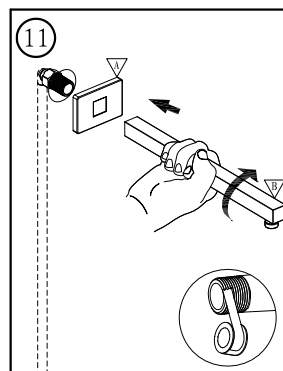
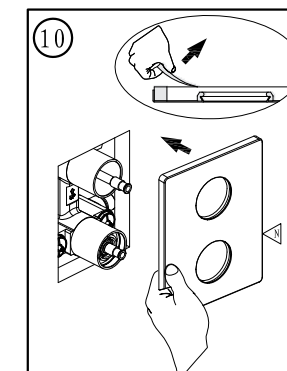
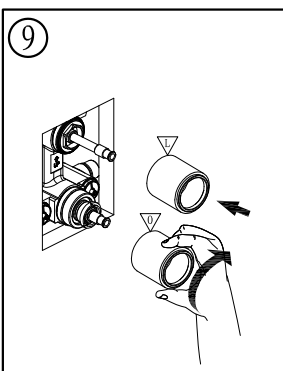
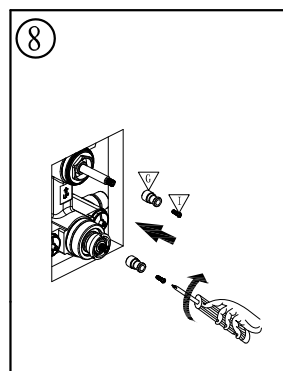

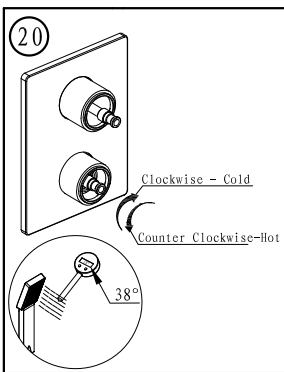
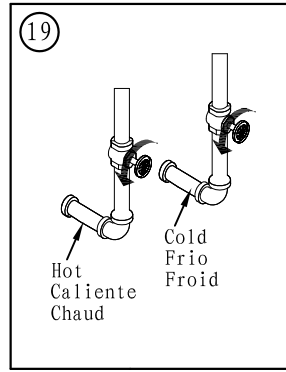
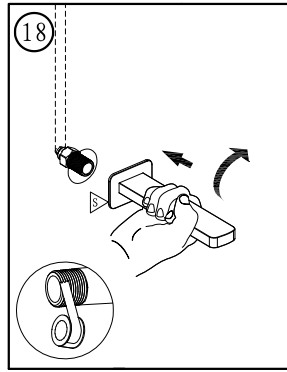
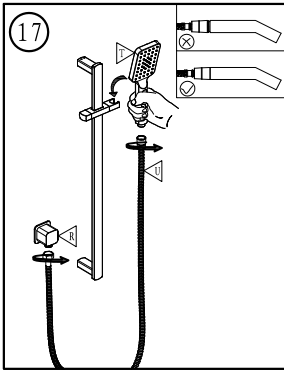
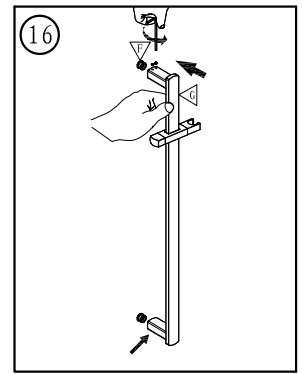
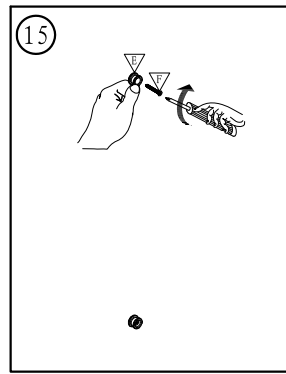
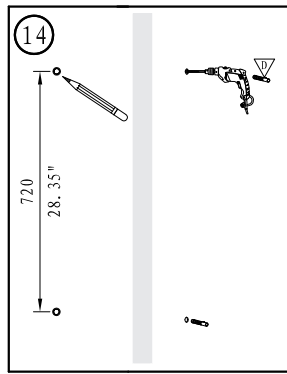
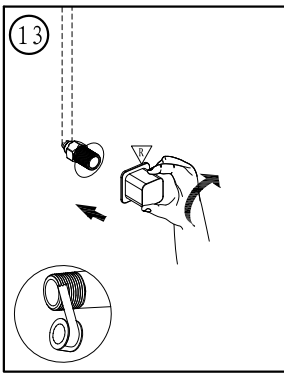

Use a thermometer to calibrate the cartridge. Make sure the water temperature is at 38° C.

